

Regular

Professional and Versatile LED Monitor

UltraView

UltraView regular LED monitor series achieve high picture quality. Improved energy efficiency and fan-less architecture provides professional-use durability and around-the-clock operation.

W19"



20"

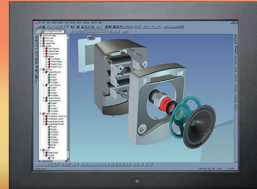

19"



17"

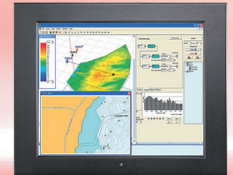

UltraView Regular professional LED is more than just a standalone monitor. UltraView has a variety of embedded modules including Multi-Monitor OSD Controller and SDI Input. The embedded modules give you the ability of video remote management and transmission for multiple monitors over network.

As a versatile Regular monitor, UltraView Regular professional LED is meticulously designed to meet professional and environmental demands including Front protection, Anti-reflective/Vandal proof glass, DC power input, Brightness dimming and Mounting kit for VESA-mount, Universal-mount, Desktop stand and Panel mount.

With over 25 years' production experience, the UltraView structure is well-engineered and manufactured by our own CNC facilities and team of experts to ensure its ruggedness, mobility and quality, as well as being suitable for harsh environment applications. The structure can be customized if required to facilitate monitor installation. Our knowledgeable engineers are able to provide frame customization for specific dimensions, color, metal treatment, screen printing, bezel and mounting.

Product Highlights

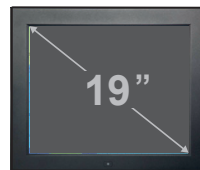

Key Benefits

- ▶ 1440 x 900 / 1600 x 1200 / 1280 x 1024 native resolution
- ▶ 16.7 M colors
- ▶ HDMI 1.4 & VGA video input ; Optional DP & DVI-D
- ▶ Video decoding capability up to 1080p (option)
- ▶ Rugged structure ensures high mobility
- ▶ IP65 front protection (NAP series)
- ▶ Professional-use durability & around-the-clock operation
- ▶ 2-year standard warranty (upgradable up to 5 years)

Applications

- Broadcasting / Advertising
- Traffic control / Command center
- Directory / Ticket kiosk
- Surveillance system
- Vehicle mount display
- Bathroom TV

Options

- DC power
- Touchscreen
- IP65 front protection
- Custom chassis & mounting
- Sunlight readable panel (W19", 19", 17")
- HDMI decoder & extender (W19")
- HDMI quad display 1080p (W19")
- Multi monitor OSD control module
- 3G / HD / SD-SDI input module
- Auto dimming
- Manual dimming

20" ~ 17"

Professional and Versatile LED Monitor

UltraView

Standard Brightness

6mm aluminum front bezel



AP-W19
AP-20
AP-19
AP-17

6mm aluminum front bezel
NEMA 4 / IP65 front protection

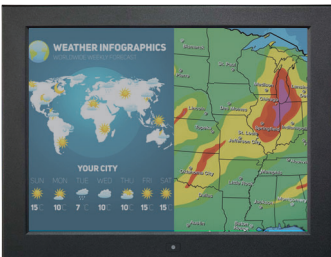

NAP-W19
NAP-20
NAP-19
NAP-17

Aluminum front cover



DP-W19
DP-20
DP-19
DP-17

Universal open frame



OP-W19
OP-20
OP-19
OP-17

1000 cd/m² Sunlight Readable Brightness

6mm aluminum front bezel



HAP-W19
HAP-19
HAP-17

6mm aluminum front bezel
NEMA 4 / IP65 front protection

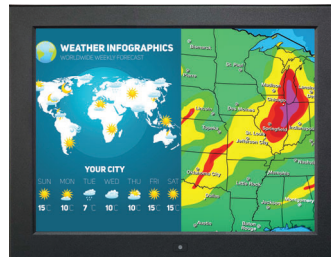

NHAP-W19
NHAP-19
NHAP-17

Aluminum front cover



HDP-W19
HDP-19
HDP-17

Universal open frame



HOP-W19
HOP-19
HOP-17

Chassis customization

- ▶ Dimension
- ▶ Color & Treatment
- ▶ Screen Printing
- ▶ Stainless Steel Bezel

Options — Touchscreen & Glass Protection

Touchscreen type	W19"	20"	19"	17"
Projected Capacitive 10-point			✓	✓
e-Capacitive 1-point			✓	✓
e-Resistive 1-point	✓	✓	✓	✓
Anti-reflective Glass			✓	
Vandal Proof Glass			✓	

Specification : e-Capacitive 1-point Touch

	TCB e-Capacitive
Technology	Capacitive
Touch Point	Single
Input Type	Finger
Resolution	2048 x 2048
Response Speed	20 ms
Activation Force	≤ 50 g
Surface Hardness	9H
Light Transmission	92% ± 2%
Haze	7%
Durability	300 million touches
Top / Bottom Layer	Glass
Thickness	2.8 mm ± 10%
Connector	USB Type A
Compatibility	Windows 7 / XP / Linux / Mac

Part no. : TCB (for 19" / 17")

Specification : e-Resistive 1-point Touch

	TRB e-Resistive
Technology	5-Wire Resistive
Touch Point	Single
Input Type	Finger or Stylus
Resolution	2048 x 2048
Response Speed	15 ms
Activation Force	≤ 50 g
Surface Hardness	3H
Light Transmission	80% ± 3%
Haze	8% ± 3%
Durability	10 million touches
Top Layer	ITO Film
Bottom Layer	ITO Glass
Thickness	3.2 ± 0.2 mm
Connector	USB Type A
Compatibility	Windows 7 / XP / Linux / Mac

Part no. : TRB

Specification : Projected Capacitive 10-point Touch

	TPC-10 Multi-touch
Technology	Projected Capacitive
Touch Point	10 point touch standard (special requirement available)
Input Type	Finger or Capacitive Stylus
Resolution	4096 x 4096
Touch Point Accuracy	± 2 mm
Response Speed	< 5 ms
Activation Force	< 5 g
Surface Hardness	6H
Light Transmission	> 85%
Haze	3% ↓
Durability	50 million touches
Top Layer	1.1 mm Glass
Bottom Layer	0.7 mm Sensor Glass
Thickness	2 mm
Connector	USB
Compatibility	Windows / Linux / Android / Mac

Part no. : TPC10 (for W19 / 19" / 17")

Options — DC Power

		12V	24V	48V	125V
Input rating	Input voltage	12-Volt	24-Volt	48-Volt	110-Volt
	Input range	9 ~ 18V	18 ~ 36V	36 ~ 75V	66 ~ 160V
Input current	No load	50 mA	50 mA	50 mA	35 mA
	Full load	4950 mA	2450 mA	1220 mA	749 mA
Output rating	Output voltage	12-Volt	12-Volt	12-Volt	12-Volt
	Output current	4.16A	4.16A	4.16A	6.25A
Efficiency		84%	85%	85%	91%

Part no. : 12VDC
24VDC
48VDC
125VDC

Options — Video Management & Transmission over Network

Embedded HDMI Decoder Module 1080p over IP (for W19 only)

- Decodes RTSP, RTMP, UDP, HTTP, HLS protocols
- Supports video resolutions up to 1080p / 60Hz
- Unicast and multicast support
- Operates on standard 1000Mb Ethernet networks
- Built-in Web UI for configuration and control
- Excellent image quality with very low delay

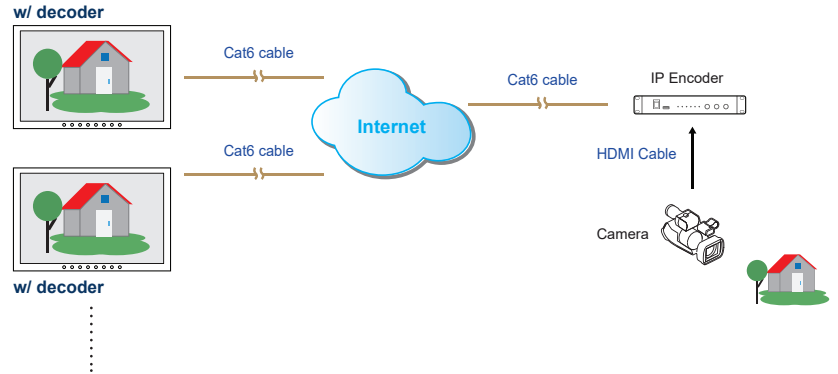

Part no.

Embedded HDMI Decoder Module : **UV-DE100F**

Standalone HDMI Encoder : **UV-EN100F**

Embedded HDMI Receiver Module 1080p (for W19 only)

- Extends the HDMI signal over a single Cat5/6 cable
- Supports video resolutions up to 1080p / 60Hz
- One to one just via Cat5/6 cable
- One to multi via network hub and Cat5/6 cable
- 100m maximum Cat5/6 cable distance
- Supports bi-directional IR communication
- High Speed HDMI 1.4 and HDCP 1.4 compliant
- No software or drivers required

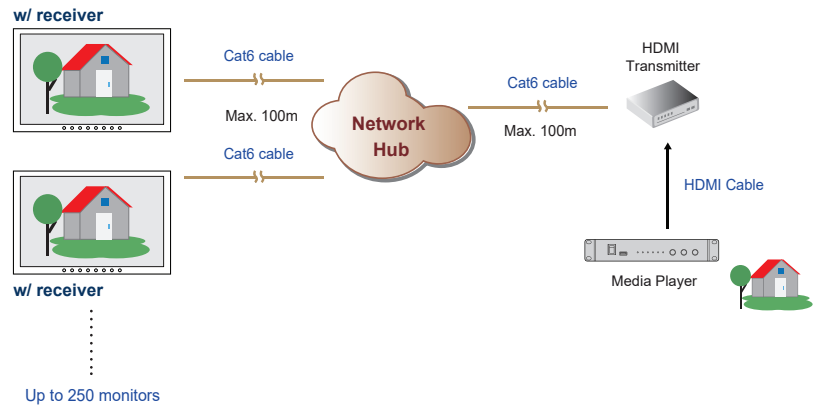

Part no.

Embedded HDMI Receiver Module : **UV-R100F**

Standalone HDMI Transmitter : **UV-T100F**

Embedded HDMI Quad Display Module 1080p (for W19 only)

- Allows 4 x HDMI inputs to be monitored simultaneously
- Quad split, panel left and full screen monitoring modes
- High speed HDMI 1.4 and HDCP 1.4 compliant
- Supports video resolutions up to 1080p / 60Hz
- Supports Scaler Up and Down function
- Control via local front panel and IR remote

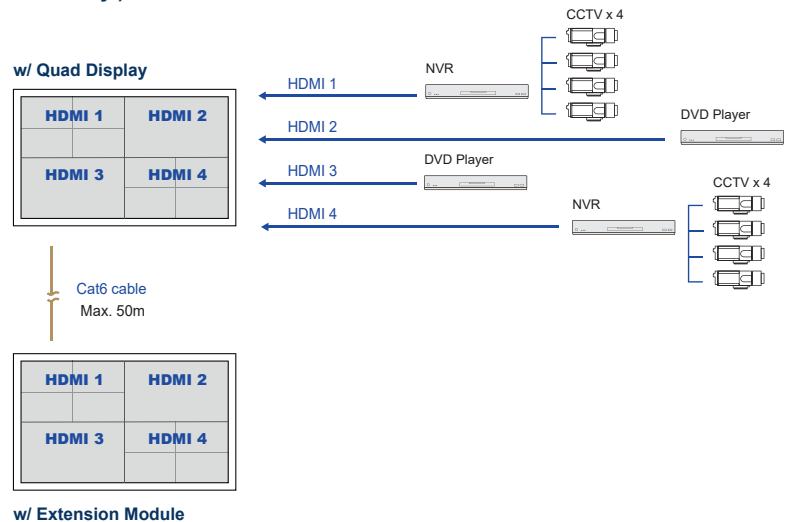

Part no.

Embedded HDMI Quad Display Module : **QD-1080**

Embedded Quad Display Extension Module : **QD-E1080**

Options — Video Management & Transmission over Network

Embedded Multi Monitor OSD Control Module over serial

- Remote control the monitor OSD via RS-232C serial interface
- Daisy chain up to 64 monitors via Cat5/6 cable
- Individual ID for individual monitor OSD settings
- Power ON or OFF monitor
- Adjust brightness & audio
- Switch video sources

Up to 64 monitors
Up to 1,000m distance

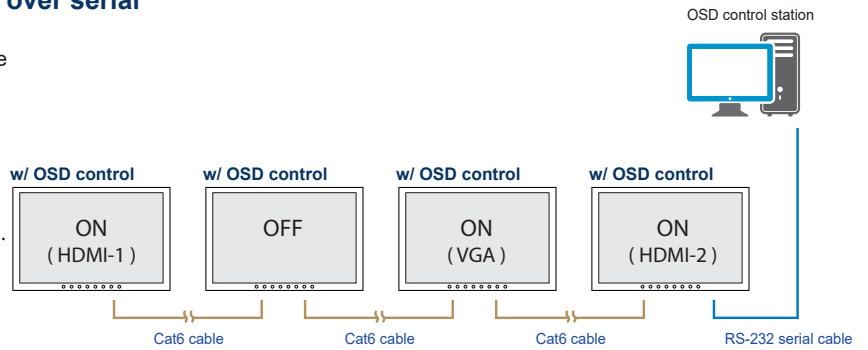

Part no.
Embedded Multi Monitor OSD Control Module : **MCS**

Embedded 3G / HD / SD-SDI Input Module

- Intelligent SDI monitoring with broadcast quality scopes
- Supports multi-rate 3G / HD / SD-SDI format
- Provides input to output loop-through capability
- Auto format sensing & selection

Part no.
Embedded 3G / HD / SD-SDI Input Module : **SDI**

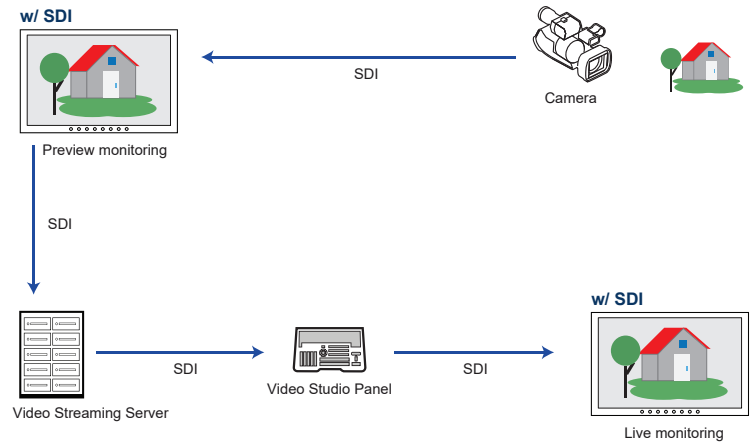

Embedded Manual Brightness Dimming Knob

- Easy-to-use IP54 dimming knob on the front panel
- One click causes 2% brightness increase or decrease
- Brightness adjustment from 0% to 100%

Part no.
Brightness Dimming Knob : **DS-01**

Embedded Auto Brightness Dimming Module

- Brightness changes according to its ambient brightness
- Its brightness change causes 10% increase or decrease

Part no.
Embedded Brightness Auto Dimming Module : **DA-01**

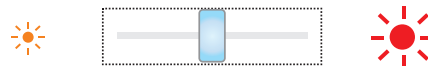

Product Specifications

LCD Panel	W19	H-W19	20"	19"	H-19"	17"	H-17"
Panel size (diagonal)	19"		20"	19"		17"	
Native resolution	1440 x 900		1600 x 1200	1280 x 1024			
Brightness (cd/m ²)	250	1000	300	250	1000	250	1000
Contrast ratio (typ.)	1000 : 1		800 : 1	1000 : 1		1000 : 1	
Colors	16.7 M						
Viewing angle (L/R/U/D)	85/85/80/80	80/80/80/80	89/89/89/89	85/85/80/80			
Response time (ms)	5		16	5			
Dot pitch (mm)	0.2835		0.255	0.294		0.264	
Display area (mm)	408.24H x 255.15V		408H x 306V	376.32H x 301.06V		337.92H x 270.33V	
Surface treatment	Anti-glare	Haze 25%, Hard-coating	Anti-glare, Hard-coating	Haze 25%, Hard-coating		Haze 25%, Hard-coating	Anti-glare
Surface hardness	3H						
Backlight type	LED		CCFL	LED			
MTBF (hrs)	30,000	50,000	45,000	30,000		30,000	50,000

Mounting	W19	H-W19	20"	19"	H-19"	17"	H-17"
VESA mount <small>(bundle)</small>	100 x 100 mm		100 x 100 mm	100 x 100 mm		100 x 100 mm	
Universal mount <small>(ready)</small>	OP only		OP only	OP only		OP only	
Overhead tilted wall-mount <small>(optional)</small>	AP / NAP / DP		AP / NAP / DP	AP / NAP / DP		AP / NAP / DP	
Desktop stand <small>(optional)</small>	AP / NAP / DP		AP / NAP / DP	AP / NAP / DP		AP / NAP / DP	

Power	W19	H-W19	20"	19"	H-19"	17"	H-17"
Input	Auto-sensing 100 to 240VAC, 50 / 60Hz						
Max. Consumption :							
Screen on	20W	34W	45W	22W	39W	22W	30W
Saving mode	4W						
Button off	1W						

Design	AP	NAP	DP	OP
Protection	6mm front bezel	NEMA 4 / IP65	Front cover	Open frame
Front panel	Black, RAL 9005			-
Rear casing	Black, RAL 9005			

Video	
VGA	Analog 0.7Vp-p
HDMI	HDMI 1.4 / HDCP 1.4

Video Option	
DVI-D	DVI-D single link
Composite (BNC)	NTSC & PAL

Audio Option	
Audio input :	
Connector	3.5mm stereo jack
Impedance / Power level	30kΩ / 750mV
Audio output :	
Connector	3.5mm stereo jack
Resistance / Power level	30kΩ / 2.8V
Speaker :	
Dual stereo speaker	2W x 2

* When the audio output is connected, speaker output is OFF

VGA / DVI input		
PC signal	20" only	1600 x 1200 x 60Hz
	20" only	1400 x 1050 x 60Hz
	W19 / 20"	1440 x 900 x 60Hz
	20" only	1360 x 768 x 60Hz
		1280 x 1024 x 60 / 75Hz
		1280 x 960 x 60Hz
		1280 x 768 x 60 / 75Hz
		1152 x 864 x 75Hz
		1024 x 768 x 60 / 70 / 75Hz
		848 x 480 x 60Hz
		800 x 600 x 60 / 72 / 75Hz
Audio signal		720 x 400 x 70Hz
		640 x 480 x 60 / 72 / 75Hz
		640 x 400 x 70Hz
		640 x 350 x 70Hz
		2ch Linear PCM

HDMI input	
PC signal	Same as VGA
HDMI 1.3 / 1.2	1280 x 720 x 50 / 60Hz (720p) 720 x 480 x 50 / 60Hz (576p / 480p)
Audio signal	2ch Linear PCM

Product Specifications

Environment	
Operating temp.	0 to 55°C degree
Storage temp.	-20 to 60°C degree
Operating humidity	10~90%, non-condensing
Storage humidity	5 ~90%, non-condensing
Operating altitude	16,000 ft
Non-operating altitude	40,000 ft
Shock	10G acceleration (11ms duration)
Vibration	10~300Hz 0.5G RMS random

Compliance	
EMC	FCC & CE
Safety	CE / LVD & UKCA
Environment	REACH & RoHS3 / WEEE

Physical Dimension & Weight

W19		AP-W19	NAP-W19	DP-W19	OP-W19
Product (W x D x H) :	mm	508.5 x 65.6 x 338.1		477.5 x 60.9 x 307.1	505.5 x 59.6 x 335.1
	inch	20 x 2.6 x 13.3		18.8 x 2.4 x 12.1	19.9 x 2.3 x 13.2
Net weight		7 kg / 15.4 lb	7 kg / 15.4 lb	6.3 kg / 13.9 lb	5.5 kg / 12.1 lb
Packing (W x D x H) :	mm	662 x 115 x 533			
	inch	26.1 x 4.5 x 21			
Gross weight		10 kg / 22 lb	10 kg / 22 lb	9.2 kg / 20.2 lb	8.4 kg / 18.5 lb

20"		AP-20"	NAP-20"	DP-20"	OP-20"
Product (W x D x H) :	mm	512.5 x 72.1 x 391.6		481.5 x 67.4 x 360.6	509.5 x 66.1 x 388.6
	inch	20.2 x 2.8 x 15.4		19 x 2.7 x 14.2	20.1 x 2.6 x 15.3
Net weight		7 kg / 15.4 lb	7 kg / 15.4 lb	6.5 kg / 14.3 lb	6 kg / 13.2 lb
Packing (W x D x H) :	mm	651 x 124 x 597			
	inch	25.6 x 4.9 x 23.5			
Gross weight		9 kg / 19.8 lb	9 kg / 19.8 lb	8.5 kg / 17 lb	8 kg / 17.6 lb

19"		AP-19"	NAP-19"	DP-19"	OP-19"
Product (W x D x H) :	mm	476.5 x 63.6 x 384.1		445.5 x 58.9 x 353.1	473.5 x 57.6 x 381.1
	inch	18.8 x 2.5 x 15.1		17.5 x 2.3 x 13.9	18.6 x 2.3 x 15
Net weight		7.7 kg / 16.9 lb	7.7 kg / 16.9 lb	6.7 kg / 14.7 lb	5.7 kg / 12.5 lb
Packing (W x D x H) :	mm	651 x 124 x 597			
	inch	25.6 x 4.9 x 23.5			
Gross weight		10.5 kg / 23.1 lb	10.5 kg / 23.1 lb	9.5 kg / 20.9 lb	8.5 kg / 18.7 lb

17"		AP-17"	NAP-17"	DP-17"	OP-17"
Product (W x D x H) :	mm	439 x 64.2 x 356.6		408 x 59.5 x 325.6	436 x 58.2 x 353.6
	inch	17.3 x 2.5 x 14		16.1 x 2.3 x 12.8	17.2 x 2.3 x 13.9
Net weight		6.6 kg / 14.5 lb	6.6 kg / 14.5 lb	5.8 kg / 12.8 lb	4.9 kg / 10.8 lb
Packing (W x D x H) :	mm	615 x 113 x 523			
	inch	24.2 x 4.4 x 20.6			
Gross weight		9.2 kg / 20.2 lb	9.2 kg / 20.2 lb	8.4 kg / 18.5 lb	7.5 kg / 16.5 lb

* All dimensions stated are subject to change if options are selected / integrated to base model part codes

UltraView Family

UltraView series covers a full range of professional LCD display sizes.
Please select from the below the most suitable model for your application.

Sales Inquiry

inquiry@austin-hughes.com

Technical Support

support@austin-hughes.com

4K

- K55"
- K43"
- K32"
- K28"
- K23"
- K17"
- K15"
- K13"

FHD

- F55" ● F21"
- F43" ● F19"
- F32" ● F17"
- F28" ● F15"
- F23" ● F13"

WXUGA (1920 x 1200)

- X24"
- X17"

Regular

- W19" (1440 x 900)
- 20" (1600 x 1200)
- 19" (1280 x 1024)
- 17" (1280 x 1024)
- 15" (1024 x 768)
- 12" (800 x 600)
- 10" (800 x 600)

High Brightness

4K

- K55"
- K43"

Sunlight Readable Brightness

FHD

- F55" ● F21"
- F43" ● F19"
- F32" ● F17"
- F15"

Regular

- W19" (1440 x 900)
- 19" (1280 x 1024)
- 17" (1280 x 1024)

Americas

Austin Hughes Solutions Inc.
32900 Alvarado-Niles Rd, Suite 150
Union City, CA 94587
United States

inquiry@austin-hughes.com

EMEA

Austin Hughes Europe Ltd.
Unit 1, Chancery Gate Business Centre
Manor House Avenue
Southampton, SO15 0AE
United Kingdom

sales@austin-hughes.co.uk

APAC

Austin Hughes Electronics Ltd.
Unit 3608-12, Cable TV Tower
9 Hoi Shing Road, Tsuen Wan
Hong Kong

inquiry@austin-hughes.com

ASEAN

Austin Hughes Pte. Ltd.
164 Gul Circle
#01-07 JTC Space@Gul
Singapore 629621

inquiry@austin-hughes.com

Austin Hughes has an extensive distribution network,
including the Americas, EMEA, APAC & ASEAN
Contact your nearest sales office for details of local representation

Please ask for details of other products from Austin Hughes. Every effort has been made to ensure that the information contained herein is correct. There is a possibility that the image(s) shown may not be exactly the same as the final product. The company reserves the right to modify product specifications without prior notice and assumes no responsibility for any error which may appear in this publication.

All brand names, logo and registered trademarks are properties of their respective owners.
Copyright 2023 Austin Hughes Electronics Ltd. All rights reserved.

Distributed by:

U.T.E. electronic GmbH & Co.KG

Friedrich-Evert-Str. 86
D-58454 Witten

Tel. +49 (0)2302 28 28 3-0

Web: www.ute.de | Mail: info@ute.de

Distributor by country on application