

4K UHD

Professional and Versatile LED Monitor

UltraView

UltraView 4K Large LED monitor series supports 3840 x 2160@60Hz resolution, 4 times the resolution of FHD. True 10-bit input enables 1.07 billion colors to be presented, achieving ultimate picture quality. Reduced energy and fan-less architecture provides professional-use durability and around-the-clock operation.

K55"



K43"



K32"



K28"



UltraView 4K professional LED is more than just a standalone monitor. UltraView has a variety of embedded modules including HDMI Decoder, HDMI Extender, HDMI Quad display Extender, Multi-Monitor OSD Controller, 3G & 12G SDI Input and Portrait Mode Kit. The embedded modules give you the ability of video remote management and transmission for multiple monitors over network.

As a versatile 4K monitor, UltraView 4K professional LED is meticulously designed to meet professional and environmental demands including High brightness, Front protection, Anti-reflective/Vandal proof glass, DC power input, Brightness dimming and Mounting kit for VESA-mount, Universal-mount, Overhead tilted wall-mount and Desktop stand.

With over 25 years' production experience, the UltraView structure is well-engineered and manufactured by our own CNC facilities and team of experts to ensure its ruggedness, mobility and quality, as well as being suitable for harsh environment applications. The structure can be customized if required to facilitate monitor installation. Our knowledgeable engineers are able to provide frame customization for specific dimensions, color, metal treatment, screen printing, bezel and mounting.

Product Highlights



Key Benefits

- ▶ 3840 x 2160@60Hz native UHD resolution
- ▶ 2560 x 1440@60Hz QHD resolution support
- ▶ 1920 x 1080 & 1920 x 1200 resolution support
- ▶ 1.07 billion colors (10-bit)
- ▶ PIP Sub-screen & PBP Dual-screen viewing efficiency
- ▶ Display port 1.2 + HDMI 1.4 + HDMI 2.0 video input
- ▶ Video decoding capability up to 1080p (option)
- ▶ Rugged structure ensures high mobility
- ▶ IP65 front protection (NAP series)
- ▶ Professional-use durability & around-the-clock operation
- ▶ 2-year standard warranty (upgradable up to 5 years)

Applications

- Broadcasting / Advertising
- Traffic control / Command center
- Directory / Ticket kiosk
- Surveillance system
- Vehicle mount display
- Bathroom TV

Options

- DC power
- Touchscreen (K55"~ 32")
- IP65 front protection
- Custom chassis & mounting
- High brightness panel (K55"~ 43")
- HDMI decoder & extender
- HDMI quad display module 1080p
- Multi monitor OSD control module
- 3G / HD / SD-SDI input module
- 12G / 4K60 / SD-SDI input module
- Portrait mode module
- Auto dimming
- Manual dimming

Standard Brightness

8mm / 6mm aluminum front bezel



AP-K55
AP-K43
AP-K32
AP-K28

8mm / 6mm aluminum front bezel
NEMA 4 / IP65 front protection



NAP-K55
NAP-K43
NAP-K32
NAP-K28

Aluminum front cover

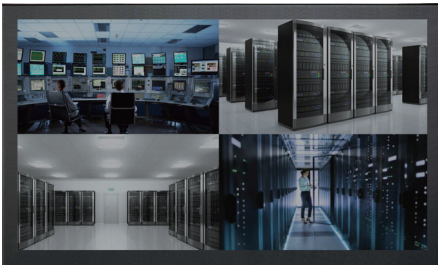

DP-K55
DP-K43
DP-K32
DP-K28

Universal open frame



OP-K55
OP-K43
OP-K32
OP-K28

700 cd/m² High Brightness

8mm / 6mm aluminum front bezel

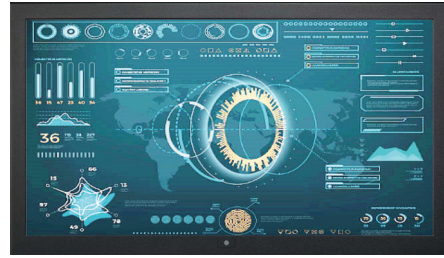

HAP-K55
HAP-K43

8mm / 6mm aluminum front bezel
NEMA 4 / IP65 front protection

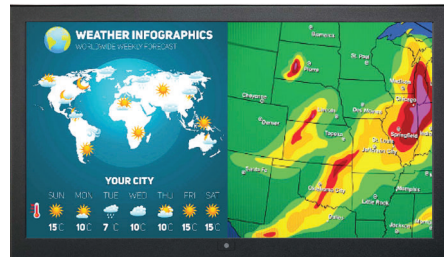

NHAP-K55
NHAP-K43

Aluminum front cover



HDP-K55
HDP-K43

Universal open frame



HOP-K55
HOP-K43

Chassis customization

- ▶ Dimension
- ▶ Color & Treatment
- ▶ Screen Printing
- ▶ Stainless Steel Bezel

Options — Touchscreen & Glass Protection

Touchscreen type	K55	K43	K32	K28
Projected Capacitive 10-point	✓	✓	✓	
Infrared 10-point	✓	✓	✓	
Anti-reflective Glass			✓	
Vandal Proof Glass			✓	

Specification : Projected Capacitive 10-point Touch

	TPC-10 Multi-touch
Technology	Projected Capacitive
Touch Point	10 point touch standard (special requirement available)
Input Type	Finger or Capacitive Stylus
Resolution	4096 x 4096
Touch Point Accuracy	± 2 mm
Response Speed	< 5 ms
Activation Force	< 5 g
Surface Hardness	6H
Light Transmission	> 85%
Haze	3%↓
Durability	50 million touches
Top Layer	3 mm Glass
Bottom Layer	1.1 mm Sensor Glass
Thickness	4.3 ± 0.25 mm
Connector	USB
Compatibility	Windows / Linux / Android / Mac

Part no. : TPC10

Specification : Infrared 10-point Touch

	IR-10 Infrared
Technology	Infrared
Touch Point	10
Input Type	Pen, Finger, Finger of gloved hand activation
Touch Point Accuracy	± 2 mm
Response Speed	≤ 15 ms
Activation Force	No minimum touch activation force
Touch Durability	Unlimited
Glass Thickness	3 mm
Connector	A-type USB
Operating System	Windows 7 / Windows 10

Part no. : IR10 (for K55 / K43 / K32)

Options — DC Power

		24V	48V	125V
Input rating	Input voltage	24-Volt	48-Volt	110-Volt
	Input range	18 ~ 36V	36 ~ 75V	66 ~ 160V
Input current	No load	50 mA	50 mA	40 mA
	Full load	4880 mA	2442 mA	993 mA
Output rating	Output voltage	24-Volt	24-Volt	24-Volt
	Output current	4.16A	4.16A	4.16A
Efficiency		88%	90%	92%

**Part no. : 24VDC
48VDC
125VDC**

Options — Video Management & Transmission over Network

Embedded HDMI Decoder Module 1080p over IP

- Decodes RTSP, RTMP, UDP, HTTP, HLS protocols
- Supports video resolutions up to 1080p / 60Hz
- Unicast and multicast support
- Operates on standard 1000Mb Ethernet networks
- Built-in Web UI for configuration and control
- Excellent image quality with very low delay

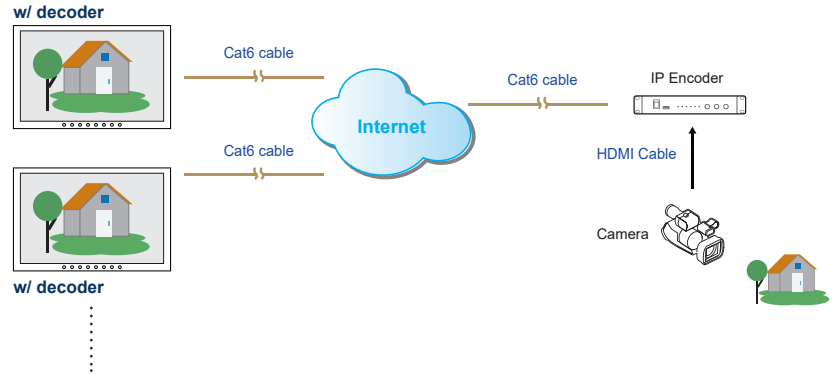

Part no.

Embedded HDMI Decoder Module : **UV-DE100F**

Standalone HDMI Encoder : **UV-EN100F**

Embedded HDMI Receiver Module 1080p

- Extends the HDMI signal over a single Cat5/6 cable
- Supports video resolutions up to 1080p / 60Hz
- One to one just via Cat5/6 cable
- One to multi via network hub and Cat5/6 cable
- 100m maximum Cat5/6 cable distance
- Supports bi-directional IR communication
- High Speed HDMI 1.4 and HDCP 1.4 compliant
- No software or drivers required

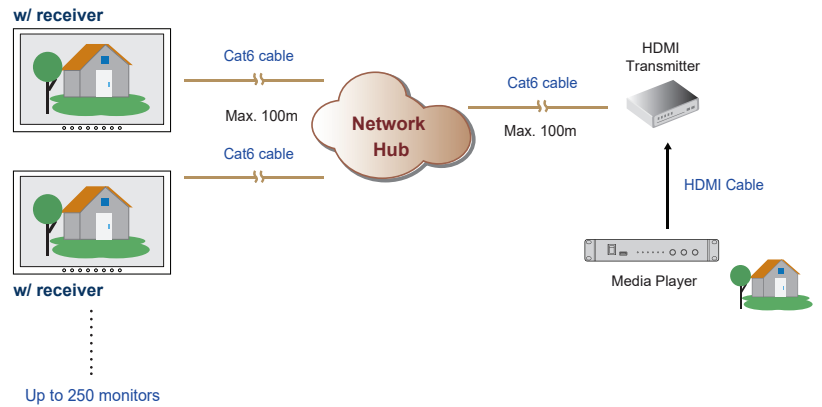

Part no.

Embedded HDMI Receiver Module : **UV-R100F**

Standalone HDMI Transmitter : **UV-T100F**

Embedded HDMI Quad Display Module 1080p

- Allows 4 x HDMI inputs to be monitored simultaneously
- Quad split, panel left and full screen monitoring modes
- High speed HDMI 1.4 and HDCP 1.4 compliant
- Supports video resolutions up to 1080p / 60Hz
- Supports Scaler Up and Down function
- Control via local front panel and IR remote

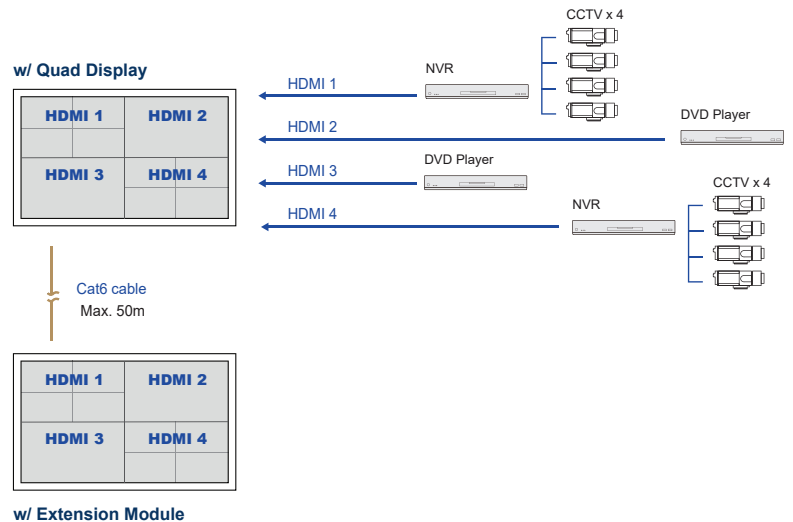

Part no.

Embedded HDMI Quad Display Module : **QD-1080**

Embedded Quad Display Extension Module : **QD-E1080**

Options — Video Management & Transmission over Network

Embedded Multi Monitor OSD Control Module over serial

- Remote control the monitor OSD via RS-232C serial interface
- Daisy chain up to 64 monitors via Cat5/6 cable
- Individual ID for individual monitor OSD settings
- Power ON or OFF monitor
- Adjust brightness & audio
- Switch video sources

Up to 64 monitors
Up to 1,000m distance

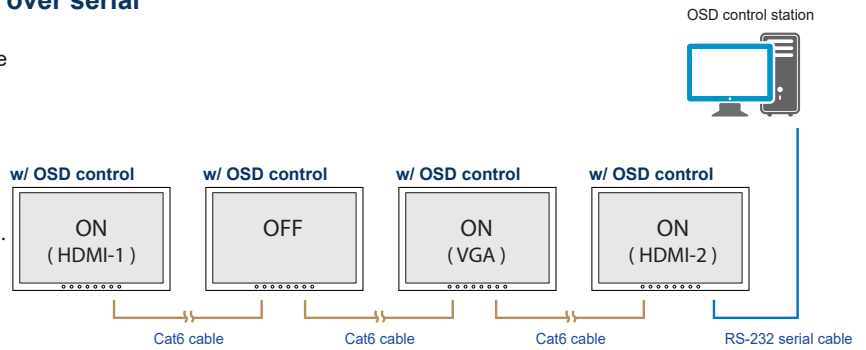

Part no.

Embedded Multi Monitor OSD Control Module : **MCS**

Embedded 3G / HD / SD-SDI Input Module
Embedded 12G / 4K60 / SD-SDI Input Module

- Intelligent SDI monitoring with broadcast quality scopes
- Supports multi-rate 3G / HD & 12G / 4K60 / SD-SDI format
- Provides input to output loop-through capability
- Auto format sensing & selection

Part no.

Embedded 3G / HD / SD-SDI Input Module : **SDI**

Embedded 12G / 4K60 / SD-SDI Input Module : **12G-SDI**

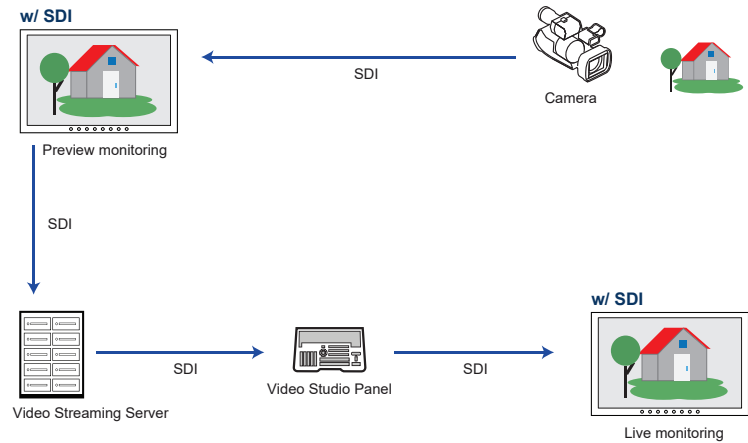

Embedded Portrait Mode Module

- Provides users with a rotation feature (0, 90, 180 & 270 orientation) without frame delay via OSD
- Allows distortion-free display of content in various orientations
- Creates new application opportunities



w/ Portrait mode module

Part no.

Embedded Portrait Mode Module : **AD4.0-P**

Embedded Auto Brightness Dimming Module

- Brightness changes according to its ambient brightness
- Its brightness change causes 10% increase or decrease

Part no.

Embedded Brightness Auto Dimming Module : **DA-01**

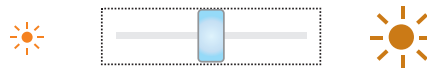



Embedded Manual Brightness Dimming Knob

- Easy-to-use IP54 dimming knob on the front panel
- One click causes 2% brightness increase or decrease
- Brightness adjustment from 0% to 100%

Part no.

Brightness Dimming Knob : **DS-01**

Product Specifications

LCD Panel	K55	H-K55	K43	H-K43	K32	K28
Panel size (diagonal)	55"		43"		31.5"	28"
Native resolution	3840 x 2160@60Hz					
Brightness (cd/m ²)	450	700 	350	700 	300	300
Contrast ratio (typ.)	1200 : 1	4000 : 1	1000 : 1	1100 : 1	1000 : 1	1000 : 1
Colors	1.07 Billion, 10-bit					
Viewing angle (L/R/U/D)	89/89/89/89					85/85/80/80
Response time (ms)	12		12		20	5
Dot pitch (mm)	0.315		0.2451		0.181	0.181
Display area (mm)	1209.60H x 680.4V		941.184H x 529.416V		698.4H x 392.85V	620.93H x 341.28V
Surface treatment	Anti-glare					
Surface hardness	2H			3H		
Backlight type	LED					
MTBF (hrs)	30,000		30,000	50,000	30,000	30,000

Mounting	K55	H-K55	K43	H-K43	K32	K28
VESA mount (bundle)	600 x 400 mm		600 x 400 mm		300 x 300 mm	100 x 100 mm
Universal mount (ready)	OP only		OP only		OP only	OP only
Overhead tilted wall-mount (optional)	AP / NAP / DP		AP / NAP / DP		AP / NAP / DP	AP / NAP / DP
Desktop stand (optional)	AP / NAP / DP		AP / NAP / DP		AP / NAP / DP	AP / NAP / DP

Power	K55	H-K55	K43	H-K43	K32	K28
Input	Auto-sensing 100 to 240VAC, 50 / 60Hz					
Max. Consumption :						
Screen on	100W	335W	68W	220W	56W	52W
Saving mode	9W					
Button off	2W					

Design	AP	NAP 	DP	OP
Protection	8mm / 6mm front bezel	NEMA 4 / IP65	Front cover	Open frame
Front panel	Black, RAL 9005			-
Rear casing	Black, RAL 9005			

Video	
Display port	DP 1.2 / HDCP 1.3
HDMI	HDMI 2.0 / HDCP 2.2 HDMI 1.4 / HDCP 1.4

Display port input	
PC signal	3840 x 2160 x 60Hz 2560 x 1440 x 60Hz 1920 x 1080 x 60Hz 1920 x 1200 x 60Hz 1600 x 1200 x 60Hz 1280 x 1024 x 60 / 75Hz 1024 x 768 x 60 / 70 / 75Hz 800 x 600 x 60 / 72 / 75Hz 720 x 400 x 70Hz 640 x 480 x 60 / 72 / 75Hz
Audio signal	2ch Linear PCM

Audio	
Audio output :	
Connector	3.5mm stereo jack
Resistance / Power level	30kΩ / 2.8V
Speaker :	
Dual stereo speaker	10W x 2

* When the audio output is connected, speaker output is OFF

HDMI input	
HDMI 2.0 / PC signal	Same as Display port
HDMI 1.4	3840 x 2160 x 30 Hz 2560 x 1440 x 60 Hz 1920 x 1080 x 50 / 60Hz (1080p) 1920 x 1080 x 25 / 30Hz (1080i) 1280 x 720 x 50 / 60Hz (720p) 720 x 480 x 50 / 60Hz (576p / 480p)
Audio signal	2ch Linear PCM

Product Specifications

Environment	
Operating temp.	0 to 55°C degree
Storage temp.	-20 to 60°C degree
Operating humidity	10~90%, non-condensing
Storage humidity	5 ~90%, non-condensing
Operating altitude	16,000 ft
Non-operating altitude	40,000 ft
Shock	10G acceleration (11ms duration)
Vibration	10~300Hz 0.5G RMS random

Compliance	
EMC	FCC & CE
Safety	CE / LVD & UKCA
Environment	REACH & RoHS3 / WEEE

Physical Dimension & Weight

K55"		AP-K55	NAP-K55	DP-K55	OP-K55
Product (W x D x H) :	mm	1295 x 89.3 x 776		1269 x 83.1 x 750	1292 x 81.3 x 773
	inch	51 x 3.5 x 30.6		50 x 3.3 x 29.5	50.9 x 3.3 x 30.4
Net weight		40 kg / 88 lb	48.6 kg / 106.9 lb	37 kg / 81.4 lb	33 kg / 72.6 lb
Packing (W x D x H) :	mm	1455 x 212 x 917			
	inch	57.3 x 8.3 x 36.1			
Gross weight		50 kg / 110 lb	58.6 kg / 128.9 lb	47 kg / 103.4 lb	43 kg / 94.6 lb

K43"		AP-K43	NAP-K43	DP-K43	OP-K43
Product (W x D x H) :	mm	1025 x 82.8 x 619		999 x 76.8 x 593	1022 x 74.8 x 616
	inch	40.4 x 3.3 x 24.4		39.3 x 3 x 23.3	40.2 x 2.9 x 24.3
Net weight		31.7 kg / 69.7 lb	37.2 kg / 81.8 lb	29 kg / 63.8 lb	26.2 kg / 57.6 lb
Packing (W x D x H) :	mm	1122 x 199 x 712			
	inch	44.2 x 7.8 x 28			
Gross weight		37.5 kg / 82.5 lb	43 kg / 94.6 lb	34.8 kg / 76.6 lb	32 kg / 70.4 lb

K32"		AP-K32	NAP-K32	DP-K32	OP-K32
Product (W x D x H) :	mm	780 x 88.2 x 474		758 x 84.2 x 452	777 x 82.2 x 471
	inch	30.7 x 3.5 x 18.7		29.8 x 3.3 x 17.8	30.6 x 3.2 x 18.5
Net weight		20.9 kg / 46 lb	23.9 kg / 52.6 lb	18.7 kg / 41.1 lb	16.4 kg / 36.1 lb
Packing (W x D x H) :	mm	910 x 195 x 580			
	inch	35.8 x 7.7 x 22.8			
Gross weight		25.7 kg / 56.5 lb	28.7 kg / 63.14 lb	23.5 kg / 51.7 lb	21.2 kg / 46.6 lb

K28"		AP-K28	NAP-K28	DP-K28	OP-K28
Product (W x D x H) :	mm	703.9 x 71.3 x 424.5		681.9 x 66.8 x 402.5	700.9 x 64.8 x 421.5
	inch	27.7 x 2.8 x 16.7		26.8 x 2.6 x 15.8	27.6 x 2.6 x 16.6
Net weight		16.8 kg / 37 lb	18.6 kg / 40.9 lb	14.8 kg / 32.6 lb	12.7 kg / 27.9 lb
Packing (W x D x H) :	mm	785 x 175 x 527			
	inch	30.9 x 6.9 x 20.7			
Gross weight		20.4 kg / 44.9 lb	22.2 kg / 48.8 lb	18.4 kg / 40.5 lb	16.3 kg / 35.9 lb

* All dimensions stated are subject to change if options are selected / integrated to base model part codes

UltraView Family

UltraView series covers a full range of professional LCD display sizes. Please select from the below the most suitable model for your application.

Sales Inquiry

inquiry@austin-hughes.com

Technical Support

support@austin-hughes.com

4K

- K55"
- K43"
- K32"
- K28"
- K23"
- K17"
- K15"
- K13"

FHD

- F55" ● F21"
- F43" ● F19"
- F32" ● F17"
- F28" ● F15"
- F23" ● F13"

WXUGA

(1920 x 1200)

- X24"
- X17"

Regular

- W19" (1440 x 900)
- 20" (1600 x 1200)
- 19" (1280 x 1024)
- 17" (1280 x 1024)
- 15" (1024 x 768)
- 12" (800 x 600)
- 10" (800 x 600)

High Brightness

4K

- K55"
- K43"

Sunlight Readable Brightness

FHD

- F55" ● F21"
- F43" ● F19"
- F32" ● F17"
- F15"

Regular

- W19" (1440 x 900)
- 19" (1280 x 1024)
- 17" (1280 x 1024)

Americas

Austin Hughes Solutions Inc.
32900 Alvarado-Niles Rd, Suite 150
Union City, CA 94587
United States

inquiry@austin-hughes.com

EMEA

Austin Hughes Europe Ltd.
Unit 1, Chancery Gate Business Centre
Manor House Avenue
Southampton, SO15 0AE
United Kingdom

sales@austin-hughes.co.uk

APAC

Austin Hughes Electronics Ltd.
Unit 3608-12, Cable TV Tower
9 Hoi Shing Road, Tsuen Wan
Hong Kong

inquiry@austin-hughes.com

ASEAN

Austin Hughes Pte. Ltd.
164 Gul Circle
#01-07 JTC Space@Gul
Singapore 629621

inquiry@austin-hughes.com

Austin Hughes has an extensive distribution network, including the Americas, EMEA, APAC & ASEAN. Contact your nearest sales office for details of local representation.

Please ask for details of other products from Austin Hughes. Every effort has been made to ensure that the information contained herein is correct. There is a possibility that the image(s) shown may not be exactly the same as the final product. The company reserves the right to modify product specifications without prior notice and assumes no responsibility for any error which may appear in this publication.

All brand names, logo and registered trademarks are properties of their respective owners. Copyright 2023 Austin Hughes Electronics Ltd. All rights reserved.

Distributed by:

U.T.E. electronic GmbH & Co.KG

Friedrich-Evert-Str. 86

D-58454 Witten

Tel. +49 (0)2302 28 28 3-0

Web: www.ute.de | Mail: info@ute.de

Distributor by country on application