

FHD

UltraView

Professional and Versatile LED Monitor

UltraView FHD LED monitor series supports 1920 x 1080 resolution, achieving optimal picture quality. Improved energy efficiency and fan-around-the-clock operation.

F21"



F19"



F17"



F15"



F13"



UltraView FHD professional LED is more than just a standalone monitor. UltraView has a variety of embedded modules including HDMI Decoder, HDMI Extender, Multi-Monitor OSD Controller, SDI Input. The embedded modules give you the ability of video remote management and transmission for multiple monitors over network.

As a versatile FHD monitor, UltraView FHD professional LED is meticulously designed to meet professional and environmental demands including Sunlight readable brightness, Front protection, Anti-reflective/Vandal proof glass, DC power input, Brightness dimming and Mounting kit for VESA-mount, Panel-mount, Universal-mount, Desktop stand and Panel-mount.

With over 25 years' production experience, the UltraView structure is well-engineered and manufactured by our own CNC facilities and team of experts to ensure its ruggedness, mobility and quality, as well as being suitable for harsh environment applications. The structure can be customized if required to facilitate monitor installation. Our knowledgeable engineers are able to provide frame customization for specific dimensions, color, metal treatment, screen printing, bezel and mounting.

Product Highlights



Key Benefits

- ▶ 1920 x 1080 native FHD resolution
- ▶ F21", F19" : 16.7 million colors
- ▶ F17", F15" & F13" : 16.7 million colors (8-bit)
- ▶ HDMI 1.4 & VGA video input
- ▶ DP / HDMI 2.0 / DVI-D video input (option)
- ▶ Video decoding capability up to 1080p (option)
- ▶ Rugged structure ensures high mobility
- ▶ IP65 front protection (NAP series)
- ▶ Professional-use durability & around-the-clock operation
- ▶ 2-year standard warranty (upgradable up to 5 years)

Applications

- Broadcasting / Advertising
- Traffic control / Command center
- Directory / Ticket kiosk
- Surveillance system
- Vehicle mount display
- Bathroom TV

Options

- DC power
- Touchscreen
- IP65 front protection
- Custom chassis & mounting
- Sunlight readable panel (F21" ~ F15")
- HDMI decoder & extender
- HDMI quad display 1080p (F21")
- Multi monitor OSD control module
- 3G / HD / SD-SDI input module
- Auto dimming
- Manual dimming

F21" ~ F13"

Professional and Versatile LED Monitor

UltraView

Standard Brightness

6mm aluminum front bezel



**AP-F21
AP-F19
AP-F17
AP-F15
AP-F13**

6mm aluminum front bezel
NEMA 4 / IP65 front protection

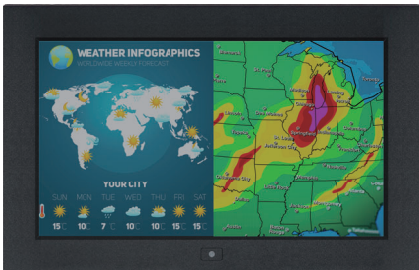

**NAP-F21
NAP-F19
NAP-F17
NAP-F15
NAP-F13**

Aluminum front cover

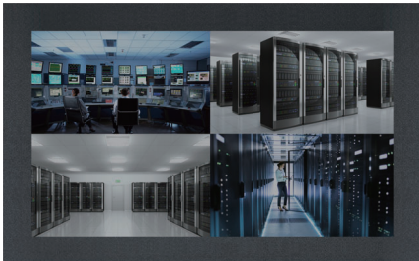

**DP-F21
DP-F19
DP-F17
DP-F15
DP-F13**

Universal open frame



**OP-F21
OP-F19
OP-F17
OP-F15
OP-F13**

1000 cd/m² Sunlight Readable Brightness

6mm aluminum front bezel



**HAP-F21
HAP-F19
HAP-F17
HAP-F15**

6mm aluminum front bezel
NEMA 4 / IP65 front protection

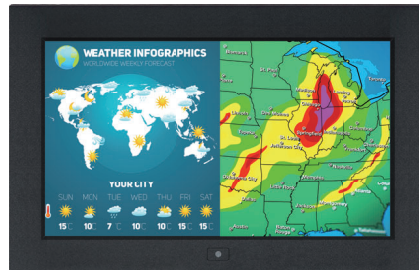

**NHAP-F21
NHAP-F19
NHAP-F17
NHAP-F15**

Aluminum front cover

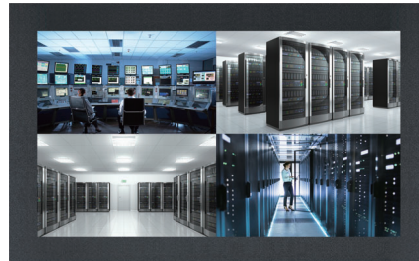

**HDP-F21
HDP-F19
HDP-F17
HDP-F15**

Universal open frame



**HOP-F21
HOP-F19
HOP-F17
HOP-F15**

Chassis customization

- ▶ Dimension
- ▶ Color & Treatment
- ▶ Screen Printing
- ▶ Stainless Steel Bezel

Options — Touchscreen & Glass Protection

Touchscreen type	F21	F19	F17	F15	F13
Projected Capacitive 10-point	✓	✓	✓	✓	✓
e-Capacitive 1-point	✓				
e-Resistive 1-point	✓	✓	✓	✓	✓
Infrared 6-point					
Anti-reflective Glass			✓		
Vandal Proof Glass			✓		

Specification : Projected Capacitive 10-point Touch

	TPC-10 Multi-touch
Technology	Projected Capacitive
Touch Point	10 point touch standard (special requirement available)
Input Type	Finger or Capacitive Stylus
Resolution	4096 x 4096
Touch Point Accuracy	± 2 mm
Response Speed	< 5 ms
Activation Force	< 5 g
Surface Hardness	6H
Light Transmission	> 85%
Haze	3% ↓
Durability	50 million touches
Top Layer	1.1 mm Glass
Bottom Layer	0.7 mm Sensor Glass
Thickness	2 mm
Connector	USB
Compatibility	Windows / Linux / Android / Mac

Part no. : TPC10

Specification : e-Resistive 1-point Touch

	TRB e-Resistive
Technology	5-Wire Resistive
Touch Point	Single
Input Type	Finger or Stylus
Resolution	2048 x 2048
Response Speed	15 ms
Activation Force	≤ 50 g
Surface Hardness	3H
Light Transmission	80% ± 3%
Haze	8% ± 3%
Durability	10 million touches
Top Layer	ITO Film
Bottom Layer	ITO Glass
Thickness	3.2 ± 0.2 mm
Connector	USB Type A
Compatibility	Windows 7 / XP / Linux / Mac

Part no. : TRB

Specification : e-Capacitive 1-point Touch

	TCB e-Capacitive
Technology	Capacitive
Touch Point	Single
Input Type	Finger
Resolution	2048 x 2048
Response Speed	20 ms
Activation Force	≤ 50 g
Surface Hardness	9H
Light Transmission	92% ± 2%
Haze	7%
Durability	300 million touches
Top / Bottom Layer	Glass
Thickness	2.8 mm ± 10%
Connector	USB Type A
Compatibility	Windows 7 / XP / Linux / Mac

Part no. : TCB

Options — DC Power

		12V	24V	48V	125V
Input rating	Input voltage	12-Volt	24-Volt	48-Volt	110-Volt
	Input range	9 ~ 18V	18 ~ 36V	36 ~ 75V	66 ~ 160V
Input current	No load	50 mA	50 mA	50 mA	35 mA
	Full load	4950 mA	2450 mA	1220 mA	749 mA
Output rating	Output voltage	12-Volt	12-Volt	12-Volt	12-Volt
	Output current	4.16A	4.16A	4.16A	6.25A
Efficiency		84%	85%	85%	91%

Part no. : 12VDC
24VDC
48VDC
125VDC

Options — Video Management & Transmission over Network

Embedded HDMI Decoder Module 1080p over IP

- Decodes RTSP, RTMP, UDP, HTTP, HLS protocols
- Supports video resolutions up to 1080p / 60Hz
- Unicast and multicast support
- Operates on standard 1000Mb Ethernet networks
- Built-in Web UI for configuration and control
- Excellent image quality with very low delay

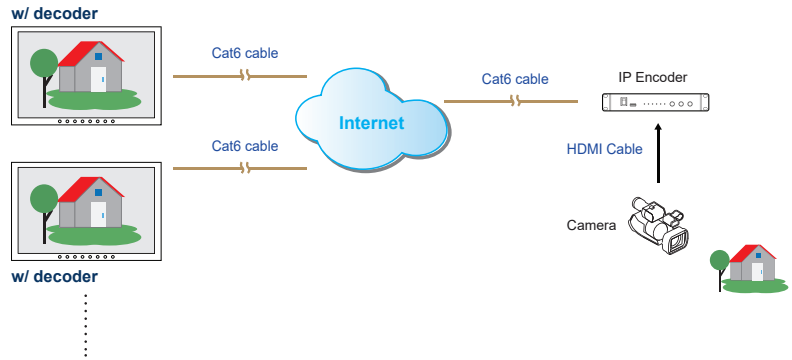

Part no.

Embedded HDMI Decoder Module : **UV-DE100F**
 Standalone HDMI Encoder : **UV-EN100F**

Embedded HDMI Receiver Module 1080p

- Extends the HDMI signal over a single Cat5/6 cable
- Supports video resolutions up to 1080p / 60Hz
- One to one just via Cat5/6 cable
- One to multi via network hub and Cat5/6 cable
- 100m maximum Cat5/6 cable distance
- Supports bi-directional IR communication
- High Speed HDMI 1.4 and HDCP 1.4 compliant
- No software or drivers required

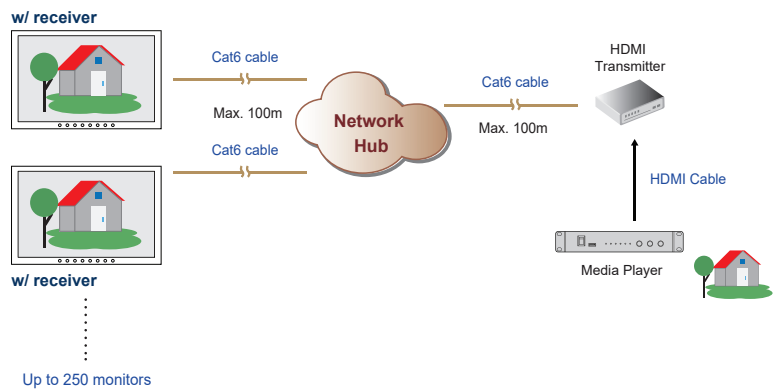

Part no.

Embedded HDMI Receiver Module : **UV-R100F**
 Standalone HDMI Transmitter : **UV-T100F**

Embedded HDMI Quad Display Module 1080p (For F23, F21 series)

- Allows 4 x HDMI inputs to be monitored simultaneously
- Quad split, panel left and full screen monitoring modes
- High speed HDMI 1.4 and HDCP 1.4 compliant
- Supports video resolutions up to 1080p / 60Hz
- Supports Scaler Up and Down function
- Control via local front panel and IR remote

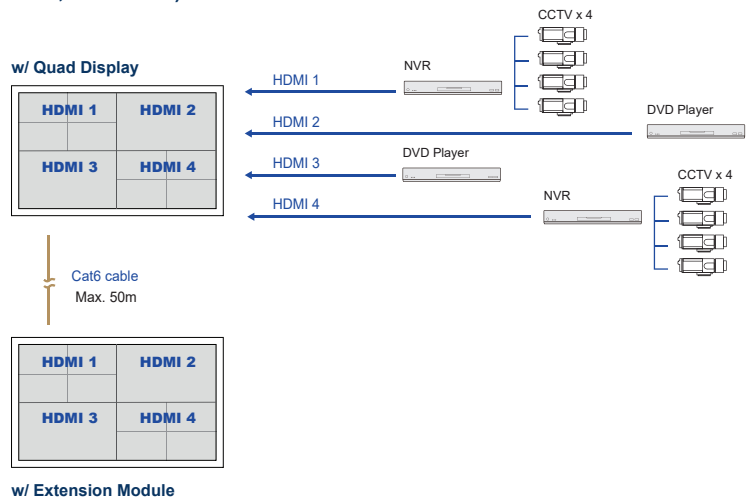

Part no.

Embedded HDMI Quad Display Module : **QD-1080**
 Embedded Quad Display Extension Module : **QD-E1080**

Options — Video Management & Transmission over Network

Embedded Multi Monitor OSD Control Module over serial

- Remote control the monitor OSD via RS-232C serial interface
- Daisy chain up to 64 monitors via Cat5/6 cable
- Individual ID for individual monitor OSD settings
- Power ON or OFF monitor
- Adjust brightness & audio
- Switch video sources

Up to 64 monitors
Up to 1,000m distance

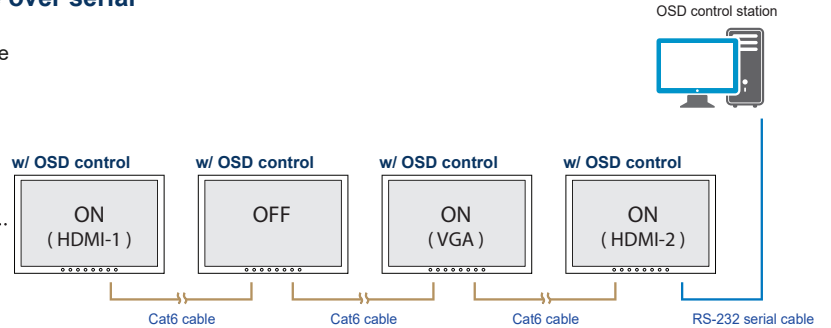

Part no.

Embedded Multi Monitor OSD Control Module : **MCS**

Embedded 3G / HD / SD-SDI Input Module

- Intelligent SDI monitoring with broadcast quality scopes
- Supports multi-rate 3G / HD / SD-SDI format
- Provides input to output loop-through capability
- Auto format sensing & selection

Part no.

Embedded 3G / HD / SD-SDI Input Module : **SDI**

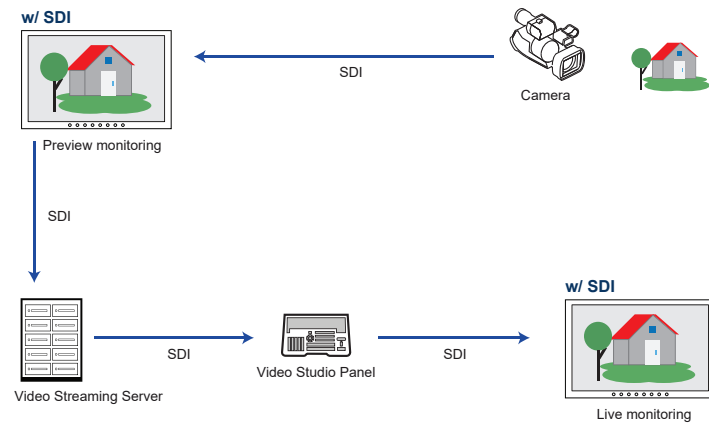

Embedded Auto Brightness Dimming Module

- Brightness changes according to its ambient brightness
- Its brightness change causes 10% increase or decrease

Part no.

Embedded Brightness Auto Dimming Module : **DA-01**

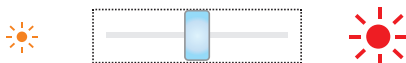

Embedded Manual Brightness Dimming Knob

- Easy-to-use IP54 dimming knob on the front panel
- One click causes 2% brightness increase or decrease
- Brightness adjustment from 0% to 100%

Part no.

Brightness Dimming Knob : **DS-01**

Product Specifications

LCD Panel	F21	H-F21	F19	H-F19	F17	H-F17	F15	H-F15	F13
Panel size (diagonal)	21.5"		18.5"		17.3"		15.6"		13"
Native resolution	1920 x 1080								
Brightness (cd/m ²)	250	1000 ^{***}	350	1000 ^{***}	300	1000 ^{***}	300	1000 ^{***}	300
Contrast ratio (typ.)	1000 : 1	5000 : 1	1000 : 1	1000 : 1	1000 : 1	600 : 1	700 : 1	500 : 1	800 : 1
Colors	16.7 M		16.7 M		16.7 M, 8-bit	16.7 M, 6-bit	16.7 M, 8-bit	16.7 M, 6-bit	16.7 M, 8-bit
Viewing angle (L/R/U/D)	85/85/80/80		89/89/89/89		85/85/85/85	80/80/60/80	89/89/89/89	70/70/60/60	85/85/85/85
Response time (ms)	5		20		25	40	30	8	25
Dot pitch (mm)	0.248		0.213		0.1989		0.2988	0.17925	0.1529
Display area (mm)	476.64H x 268.11V		408.96H x 230.04V		381.888H x 214.812V		344.22H x 193.62V	344.16H x 193.59V	293.76H x 165.24V
Surface treatment	Haze 25%, Hard-coating	Anti-glare	Anti-glare, Hard-coating		Anti-glare, Hard-coating	Hard-coating	Anti-glare		Anti-glare
Surface hardness	3H								
Backlight type	LED								
MTBF (hrs)	30,000	50,000	50,000		15,000	50,000	15,000	50,000	15,000

Mounting	F21	H-F21	F19	H-F19	F17	H-F17	F15	H-F15	F13
VESA mount (bundle)	100 x 100 mm		100 x 100 mm		100 x 100 mm		100 x 100 mm		100 x 100 mm
Universal mount (ready)	OP only		OP only		OP only		OP only		OP only
Desktop stand (optional)	AP / NAP / DP		AP / NAP / DP		AP / NAP / DP		AP / NAP / DP		AP / NAP / DP
Panel mount (optional)	AP / NAP / DP		AP / NAP / DP		AP / NAP / DP		AP / NAP / DP		AP / NAP / DP

Power	F21	H-F21	F19	H-F19	F17	H-F17	F15	H-F15	F13
Input	Auto-sensing 100 to 240VAC, 50 / 60Hz								
Max. Consumption :									
Screen on	28W	32W	12W	40W	14W	39W	9W	65W	9W
Saving mode	2W								
Button off	1W								

Design	AP	NAP	DP	OP
Protection	6mm front bezel	NEMA 4 / IP65	Front cover	Open frame
Front panel	Black, RAL 9005			-
Rear casing	Black, RAL 9005			

Video	
VGA	Analog 0.7Vp-p
HDMI	HDMI 1.4 / HDCP 1.4

Video Option	
Display port	DP1.0 / HDCP 1.3
HDMI	HDMI 2.0 / HDCP 2.2
DVI-D	DVI-D single link
Composite (BNC)	NTSC & PAL

Audio Option	
Audio input :	
Connector	3.5mm stereo jack
Impedance / Power level	30kΩ / 750mV
Audio output :	
Connector	3.5mm stereo jack
Resistance / Power level	30kΩ / 2.8V
Speaker :	
Dual stereo speaker	2W x 2

DVI-D / VGA input
PC signal :
1920 x 1080 x 60Hz
1360 x 768 x 60Hz
1280 x 1024 x 60 / 75Hz
1280 x 960 x 60Hz
1280 x 768 x 60 / 75Hz
1152 x 864 x 75Hz
1024 x 768 x 60 / 70 / 75Hz
848 x 480 x 60Hz
800 x 600 x 60 / 72 / 75Hz
720 x 400 x 70Hz
640 x 480 x 60 / 72 / 75Hz
640 x 400 x 70Hz
640 x 350 x 70Hz
Audio signal :
2ch Linear PCM

HDMI input
PC signal :
Same as VGA
HDMI 1.3 / 1.4 :
1920 x 1080 x 50 / 60Hz
1920 x 1080 x 25 / 30Hz
1280 x 720 x 50 / 60Hz
720 x 480 x 50 / 60Hz
Audio signal :
2ch Linear PCM

Display port input
PC signal :
1920 x 1080 x 60Hz
1600 x 1200 x 60Hz
1360 x 768 x 60Hz
1280 x 768 x 60 / 75Hz
1280 x 768 x 60Hz
1024 x 768 x 60 / 70 / 75Hz
800 x 600 x 60 / 72 / 75Hz
720 x 400 x 70Hz
640 x 480 x 60 / 72 / 75Hz
Audio signal :
2ch Linear PCM

F13 & F17 resolution support not listed in the above table.
For details, please refer to the user manual.

F13 **F17**

* When the audio output is connected, speaker output is OFF

Product Specifications

Environment	
Operating temp.	0 to 55°C degree *-20 to 70°C degree (F19,H-F19)
Storage temp.	-20 to 60°C degree *-20 to 70°C degree (F19,H-F19)
Operating humidity	10~90%, non-condensing *5 to 95°C degree (F19,H-F19)
Storage humidity	5 ~90%, non-condensing *5 to 95°C degree (F19,H-F19)
Operating altitude	16,000 ft
Non-operating altitude	40,000 ft
Shock	10G acceleration (11ms duration)
Vibration	10~300Hz 0.5G RMS random

Compliance	
EMC	FCC & CE
Safety	CE / LVD & UKCA
Environment	REACH & RoHS3 / WEEE

Physical Dimension & Weight

F21"		AP-F21	NAP-F21	DP-F21	OP-F21
Product (W x D x H) :	mm inch	546.8 x 56.4 x 338.3 21.5 x 2.2 x 13.3		546.8 x 56.4 x 338.3 21.5 x 2.2 x 13.3	574.8 x 52.6 x 366.3 22.6 x 2.1 x 14.4
Net weight		9 kg / 19.8 lb	9 kg / 19.8 lb	7.9 kg / 17.4 lb	6.7 kg / 14.7 lb
Packing (W x D x H) :	mm inch	659 x 117 x 640 25.9 x 4.6 x 25.2			
Gross weight		12.7 kg / 27.9 lb	12.7 kg / 27.9 lb	11.6 kg / 25.5 lb	10.4 kg / 22.9 lb

F19"		AP-F19	NAP-F19	DP-F19	OP-F19
Product (W x D x H) :	mm inch	508.5 x 65.6 x 318.1 20 x 2.6 x 12.5		477.9 x 61.2 x 287.5 18.8 x 2.4 x 11.3	505 x 59.6 x 315.1 19.9 x 2.3 x 12.4
Net weight		7 kg / 15.4 lb	7 kg / 15.4 lb	6.3 kg / 13.9 lb	5.5 kg / 12.1 lb
Packing (W x D x H) :	mm inch	662 x 115 x 533 26.1 x 4.5 x 21			
Gross weight		10 kg / 22 lb	10 kg / 22 lb	9.2 kg / 20.2 lb	8.4 kg / 18.5 lb

F17"		AP-F17	NAP-F17	DP-F17	OP-F17
Product (W x D x H) :	mm inch	468.5 x 57.1 x 331 18.4 x 2.2 x 13		437.5 x 51.9 x 300 17.2 x 2 x 11.8	465.5 x 50.6 x 328 18.3 x 2 x 12.9
Net weight		5.2 kg / 11.4 lb	5.2 kg / 11.4 lb	4.3 kg / 9.5 lb	3.4 kg / 7.5 lb
Packing (W x D x H) :	mm inch	615 x 113 x 523 24.2 x 4.4 x 20.6			
Gross weight		8 kg / 17.6 lb	8 kg / 17.6 lb	7.1 kg / 15.6 lb	6.2 kg / 13.6 lb

F15"		AP-F15	NAP-F15	DP-F15	OP-F15
Product (W x D x H) :	mm inch	399 x 55.1 x 254.5 15.7 x 2.2 x 10		376.4 x 50.7 x 231.9 14.8 x 2 x 9.1	396 x 49.1 x 251.5 15.6 x 1.9 x 9.9
Net weight		4.7 kg / 10.3 lb	4.7 kg / 10.3 lb	4.1 kg / 9 lb	3.5 kg / 7.7 lb
Packing (W x D x H) :	mm inch	615 x 113 x 523 24.2 x 4.4 x 20.6			
Gross weight		7.3 kg / 16.1 lb	7.3 kg / 16.1 lb	6.7 kg / 14.7 lb	6.1 kg / 13.4 lb

F13"		AP-F13	NAP-F13	DP-F13	OP-F13
Product (W x D x H) :	mm inch	355 x 54.9 x 252.3 14 x 2.2 x 9.9		332.4 x 50.2 x 231.7 13.1 x 2 x 9.1	355 x 50.2 x 252.3 13.9 x 2 x 9.9
Net weight		- kg / - lb	- kg / - lb	- kg / - lb	- kg / - lb
Packing (W x D x H) :	mm inch	615 x 113 x 523 24.2 x 4.4 x 20.6			
Gross weight		- kg / - lb	- kg / - lb	- kg / - lb	- kg / - lb

* All dimensions stated are subject to change if options are selected / integrated to base model part codes

UltraView Family

UltraView series covers a full range of professional LCD display sizes.
Please select from the below the most suitable model for your application.

Sales Inquiry

inquiry@austin-hughes.com

Technical Support

support@austin-hughes.com

4K

- K55"
- K43"
- K32"
- K28"
- K23"
- K17"
- K15"
- K13"

FHD

- F55" ● F21"
- F43" ● F19"
- F32" ● F17"
- F28" ● F15"
- F23" ● F13"

WXUGA (1920 x 1200)

- X24"
- X17"

Regular

- W19" (1440 x 900)
- 20" (1600 x 1200)
- 19" (1280 x 1024)
- 17" (1280 x 1024)
- 15" (1024 x 768)
- 12" (800 x 600)
- 10" (800 x 600)

High Brightness

4K

- K55"
- K43"

Sunlight Readable Brightness

FHD

- F55" ● F21"
- F43" ● F19"
- F32" ● F17"
- F15"

Regular

- W19" (1440 x 900)
- 19" (1280 x 1024)
- 17" (1280 x 1024)

Americas

Austin Hughes Solutions Inc.
32900 Alvarado-Niles Rd, Suite 150
Union City, CA 94587
United States

inquiry@austin-hughes.com

EMEA

Austin Hughes Europe Ltd.
Unit 1, Chancery Gate Business Centre
Manor House Avenue
Southampton, SO15 0AE
United Kingdom

sales@austin-hughes.co.uk

APAC

Austin Hughes Electronics Ltd.
Unit 3608-12, Cable TV Tower
9 Hoi Shing Road, Tsuen Wan
Hong Kong

inquiry@austin-hughes.com

ASEAN

Austin Hughes Pte. Ltd.
164 Gul Circle
#01-07 JTC Space@Gul
Singapore 629621

inquiry@austin-hughes.com

Austin Hughes has an extensive distribution network,
including the Americas, EMEA, APAC & ASEAN
Contact your nearest sales office for details of local representation

Please ask for details of other products from Austin Hughes. Every effort has been made to ensure that the information contained herein is correct. There is a possibility that the image(s) shown may not be exactly the same as the final product. The company reserves the right to modify product specifications without prior notice and assumes no responsibility for any error which may appear in this publication.

All brand names, logo and registered trademarks are properties of their respective owners.
Copyright 2023 Austin Hughes Electronics Ltd. All rights reserved.

Distributed by:

U.T.E. electronic GmbH & Co.KG

Friedrich-Evert-Str. 86

D-58454 Witten

Tel. +49 (0)2302 28 28 3-0

Web: www.ute.de | Mail: info@ute.de

Distributor by country on application